

EN

Version 3:
April 2023

DRAPER[®]

230V DIRECT DRIVE

OIL COMPRESSOR

24980, 24981



**UK
CA** **CE**

1. Preface

These are the original product instructions. This document is part of the product; retain it for the life of the product, passing it on to subsequent holders. Read this manual in full before attempting to assemble, operate or maintain this product.

This Draper Tools manual describes the purpose of the product and contains all the necessary information to ensure its correct and safe use. Following all the instructions and guidance in this manual will ensure the safety of both the product and the operator and increase the lifespan of the product.

All photographs and drawings within this manual are supplied by Draper Tools to help illustrate correct operation of the product.

Every effort has been made to ensure the information contained in this manual is accurate. However, Draper Tools reserves the right to amend this document without prior warning. Always use the latest version of the product manual.

1.1 Product Reference

User Manual for: Air Compressor (24L, 1.5kW / 50L, 1.5kW)

Stock No: 24980, 24981

Part No: DA25/207, DA50/207

1.2 Revisions

Version 1: December 2014
First release

Version 2: January 2021
Updated formatting and product marking

Version 3: April 2023
General content and formatting updates

As our manuals are continually updated, always ensure that the latest version is used.

Please visit drapertools.com/manuals for the latest version of this manual and the associated parts list, if applicable.

1.3 Understanding the Safety Content of This Manual



WARNING! – Situations or actions that may result in personal injury or death.



CAUTION! – Situations or actions that may result in damage to the product or surroundings.

Important: – Information or instructions of particular importance.

1.4 Copyright © Notice

Copyright © Draper Tools Limited.

Permission is granted to reproduce this manual for personal and educational use **ONLY**. Commercial copying, redistribution, hiring or lending is strictly prohibited.

No part of this manual may be stored in a retrieval system or transmitted in any other form or means without written permission from Draper Tools Limited.

In all cases, this copyright notice must remain intact.

1. Preface	2	8. Maintenance and Troubleshooting	16
1.1 Product Reference	2	8.1 General Maintenance	16
1.2 Revisions	2	8.2 Air Filter Care	16
1.3 Understanding the Safety Content of This Manual	2	8.3 Draining and Replacing the Oil	17
1.4 Copyright © Notice	2	8.4 Valve Care	17
2. Contents	3	8.5 Storing the Compressor	17
3. Product Introduction	4	8.6 Troubleshooting	18
3.1 Intended Use	4	9. Spares, Returns and Disposal	20
3.2 Specification	4	10. Warranty	21
4. Health and Safety Information	5	11. Explanation of Symbols	22
4.1 General Health and Safety Precautions	5	Notes	23
4.2 Additional Safety Instructions for This Air Compressor	6		
4.3 Connection to the Power Supply	7		
4.4 Residual Risk	7		
5. Identification and Unpacking	8		
5.1 Product Overview	8		
5.2 What's in the Box?	9		
5.3 Packaging	10		
6. Preparing the Compressor	11		
6.1 Assembly and Installation	11		
6.2 Topping Up the Oil	12		
6.3 Draining Moisture from the Tank	12		
6.4 Connecting an Air Line or Tool	13		
7. Operating Instructions	14		
7.1 First-Time Use	14		
7.2 Switching the Compressor On and Off	14		
7.3 Setting the Output Pressure	15		
7.4 Depressurising the Reservoir Tank	15		
7.5 Overload Cut-Out	15		
7.6 The Safety Valve	15		

3. Product Introduction

3.1 Intended Use

This product is an air compressor capable of supplying compressed air up to a maximum pressure of 8bar. The compressor may be used to supply air tools for applications such as blowing, spraying and inflating tyres.

Any other application beyond the conditions established for use will be considered misuse. Draper Tools accepts no responsibility for improper use of this product.

Important: This product is suitable for pressurising air **ONLY** and must **NOT** be used to pressurise any other gas.



CAUTION! This product is shipped without oil. The oil level **MUST** be checked and topped up appropriately before **EVERY** use. **DO NOT** overfill the oil reservoir.



CAUTION! This product is **NOT** continuously rated and is for intermittent use **ONLY**. Operation **MUST NOT** cause the compressor motor to activate more than five times per hour as this will cause the product to overheat and may cause significant damage.

Part of our core range, this product is suitable for use by enthusiasts and tradespersons alike. This product is not suitable for industrial use.



WARNING! This product is not a toy and must be respected.

Read this manual in full before attempting to assemble, operate or maintain the product, and retain it for later use.

3.2 Specification

Stock No.	24980	24981
Part No.	DA25/207	DA50/207
Rated voltage	220–240V AC	220–240V AC
Rated frequency	50Hz	50Hz
Rated input	1.5kW (2HP)	1.5kW (2HP)
Duty cycle	Five motor activations per hour	Five motor activations per hour
Motor		
No load speed	2,850rpm	2,850rpm
Cut-out pressure	8bar	8bar
Cut-in pressure	5.4–6.6bar	5.4–6.6bar
Max. pressure	8bar (116psi)	8bar (116psi)
Tank size	24L	50L
Air outlet	Female Euro adaptor with 1/4" BSP thread	Female Euro adaptor with 1/4" BSP thread
Air displacement	206L/min (7.3cfm)	206L/min (7.3cfm)
Free air delivery	113L/min (4cfm)	113L/min (4cfm)
Noise emissions		
Sound pressure level	71.4dB(A)	71.4dB(A)
Uncertainty	3dB(A)	3dB(A)
Sound power level	93dB(A)	93dB(A)
Uncertainty	3dB(A)	3dB(A)
Dimensions	L 580 × W 250 × H 560mm	L 765 × W 325 × H 705mm
Net weight	24kg	33kg

Important: Read all the Health and Safety instructions before attempting to operate, maintain or repair this product. Non-compliance with these instructions may result in injury or damage to the user, product or any attached items or tools.

Read this manual in conjunction with the manufacturer's instructions for any tools or materials used with this product.

 **WARNING! NEVER exceed the maximum pressure of any tool or inflatable item connected to this compressor.**

4.1 General Health and Safety Precautions

Personal Safety and Responsibility

- Only authorised personnel who have carefully read and understood this manual may operate, adjust and maintain this product.
- Observe all standard safety precautions and good practices when working with air tools and compressed air.
- Always wear adequate eye and ear protection when using this product.
- Wear protective gloves while using this product.
- Keep the product out of reach of children.
- Use the product only in the manner instructed in this manual.
- Stay alert at all times; **DO NOT** use this product while tired or under the influence of alcohol, drugs or other medication.
- Keep fingers and other body parts away from moving parts during operation.
- Keep long hair tied back and remove any loose-fitting clothes or jewellery to prevent them from becoming caught in moving parts during use.

Inspection

- Before every use, inspect the compressor for missing, broken, loose or corroded parts and leaks.
Important: **DO NOT** use this product if it is damaged or leaking in any way. Contact Draper Tools to discuss repair and replacement options.

 **WARNING! The reservoir tank walls MUST have a minimum thickness of 2.0mm. Corrosion may reduce the thickness of the tank walls and compromise the structural integrity of the reservoir, which may result in injury while the tank is under load.**

- **DO NOT** use this machine if the on/off switch or safety valve does not function correctly.
- **DO NOT** use this product if either of the gauges are unresponsive or inaccurate.
- Ensure that all connections are securely fastened and airtight before use.
- **ALWAYS** ensure that the motor air vents are clear and free from dust and debris during use.
- **DO NOT** use this product if the ratings plate or safety markings have become illegible.

Hazard Prevention

- **DO NOT** disassemble or modify this product in any way.
- **DO NOT** adjust the safety valve.
- **DO NOT** cover any part of this product during operation.
- **NEVER** immerse this product in water or expose it to damp conditions or frost.
- **DO NOT** move the compressor while it is switched on or fully pressurised.
- **NEVER** leave this product unattended while it is pressurising, pressurised or in use.
- **ONLY** use spare parts supplied by Draper Tools.

 **WARNING! Parts of this product may become hot during use. DO NOT touch the motor housing or compressor tank during use. Allow the product to cool before adjusting, moving or maintaining the product.**

Operation and Storage Conditions

- Keep your work environment clear and well-lit, with bystanders at a safe distance.
- Use this product **ONLY** in well-ventilated environments.
- **ALWAYS** use, store and transport this product in an upright position on a firm and flat surface and take precautions to prevent the product from tipping over.

 **WARNING! ALWAYS depressurise the tank after use; DO NOT store the compressor with a pressurised tank.**

4. Health and Safety Information

4.2 Additional Safety Instructions for This Air Compressor

Important: ALWAYS check local regulations regarding pressure vessels before use.

 **WARNING! The air produced by this product is NOT suitable for breathing equipment.**

Training and Correct Use

- This product is not intended for use by persons (including children) with reduced physical, sensory or mental capabilities, or lack of experience and knowledge.
 - Children should be supervised to ensure that they do not play with the product.
- **NEVER** sit, stand or ride on this product.
- This product is designed to accommodate a permanent load from internal pressure; it is **NOT** suitable for continuous cyclical use.
- **DO NOT** leave this product unattended while it is in use.
 - **DO NOT** use this product with a programmer, timer, separate remote-control system or any other device that switches the product on automatically, or on any circuit that is regularly switched on and off by the utility, as it may pose a hazard if it is switched on unattended.
- **DO NOT** use this product to supply air tools that require greater air flow than this compressor can provide.

 **CAUTION! DO NOT allow the compressor motor to activate more than five times in any given hour as they will overheat the components and may cause significant damage to the product.**

Environmental Safety and Installation

- Use this product **ONLY** in well-ventilated environments where no air pollutants, dust, acids, or flammable, explosive or toxic vapours are present.
- **DO NOT** use this product in areas with high ambient temperatures or in the vicinity of sparks, open flames or sources of ignition.
- **NEVER** use this compressor in an elevated location from which it may fall or tip over.

Working with Compressed Air

- Compressed air can cause severe injury.
 - **ALWAYS** turn off and disconnect the air supply before making any adjustments to the attached tools.
 - **NEVER** direct compressed air towards yourself or others.
 - Ensure that compressed air is not blocked by or in contact with any part of your body.
- Draper Tools recommends the use of a whip hose between connected tools and the air supply to reduce vibration.

 **CAUTION! Whipping hoses can cause severe injury. Always check for and replace damaged or loose hoses and fittings.**

- Ensure that any connected tool is compatible with the air supply before use.
- **ALWAYS** ensure that the air flow is shut off when connecting or disconnecting an air line or tool.
 - Pressurise the compressor tank before connecting an air line or tool and set the regulator to its minimum setting.
 - **DO NOT** depress the tool trigger or open the air line while connecting to the compressor.
- Ensure all connections are securely tightened.
- **DO NOT** exceed the maximum stated air pressure of this compressor or any connected tools.
 - The pressure of the air supply **MUST NOT** exceed more than 10% of the rated pressure of any connected tool.

Maintenance

- Check and top up the oil level before **EVERY** use.
- **NEVER** carry the compressor or any connected tool by the air line.
- **DO NOT** use this tool in temperatures that do not fall within 0–40°C.
- **DO NOT** use this product if you suspect that the integrity of the compressor tank has been compromised.
 - **NEVER** strike or pierce the compressor tank or expose it to flames sources or sources of heat.
 - **NEVER** weld anything to or drill holes in the compressor tank.
- Drain the compressor tank of compensation before and after **EVERY** use and before storing the product.

- Have the safety valve replaced every 12 months by an authorised service agent.
- Maintain the product correctly to help to prevent malfunction and deliver a longer lifespan for the product.
 - Clogged filters, valve malfunction and increased oil viscosity due to cold starting may result in oil starvation and cause rapid deterioration of internal parts.



WARNING! DO NOT use this product if the safety valve or gauges are damaged in any way. The tank pressure must be monitorable and able to self-vent in the event of over-pressurisation.

4.3 Connection to the Power Supply

This appliance is supplied with an approved plug and cable for your safety. The value of the fuse fitted is marked on the pin face of the plug. Should the fuse need replacing, ensure the substitute is of the correct rating, approved to BS 1363/A and ASTA or BS Kite marked.

ASTA

BSI

Replacement of the fuse should only be performed by suitably qualified personnel.

If the power supply cord is damaged, it must be replaced by Draper Tools, an authorised service agent or similarly qualified personnel in order to avoid a hazard.

The damaged or incomplete plug, when cut from the cable, shall be disabled to prevent connection to a live electrical outlet.

This product is Class I* and is designed for connection to a power supply matching that detailed on the rating label and compatible with the plug fitted.

Draper Tools recommends that this product is not used with an extension lead. However, if use of an extension is unavoidable, a compatible 2.5mm² cable rated for the appliance is recommended. Follow all the instructions supplied with the extension lead.

If the plug must be connected in an outside environment, ensure that the outlet or extension lead is suitably designed for outside use.

Important: Always follow the extension lead instructions regarding maximum load while the cable is wound. If in doubt, unwind the entire cable. A coiled extension lead generates heat which could melt the lead and cause a fire.

Draper Tools recommends that a residual current device (RCD), e.g. Draper Stock Nos. 69307 or 89301 is used with this product. **ALWAYS** read the manufacturer instructions for any RCD use. For your safety, if an extension cable is used, the RCD **MUST** be installed at the power outlet and not into the extension lead.

***Earthed:** This product requires an earth connection to protect against electric shock from accessible conductive parts in the event of a failure of the basic insulation.

4.4 Residual Risk

The safety instructions in this manual cannot account for all possible conditions and situations that may occur. Exercise common sense and caution when using this product and protect against any additional conceivable risks.

5. Identification and Unpacking

5.1 Product Overview

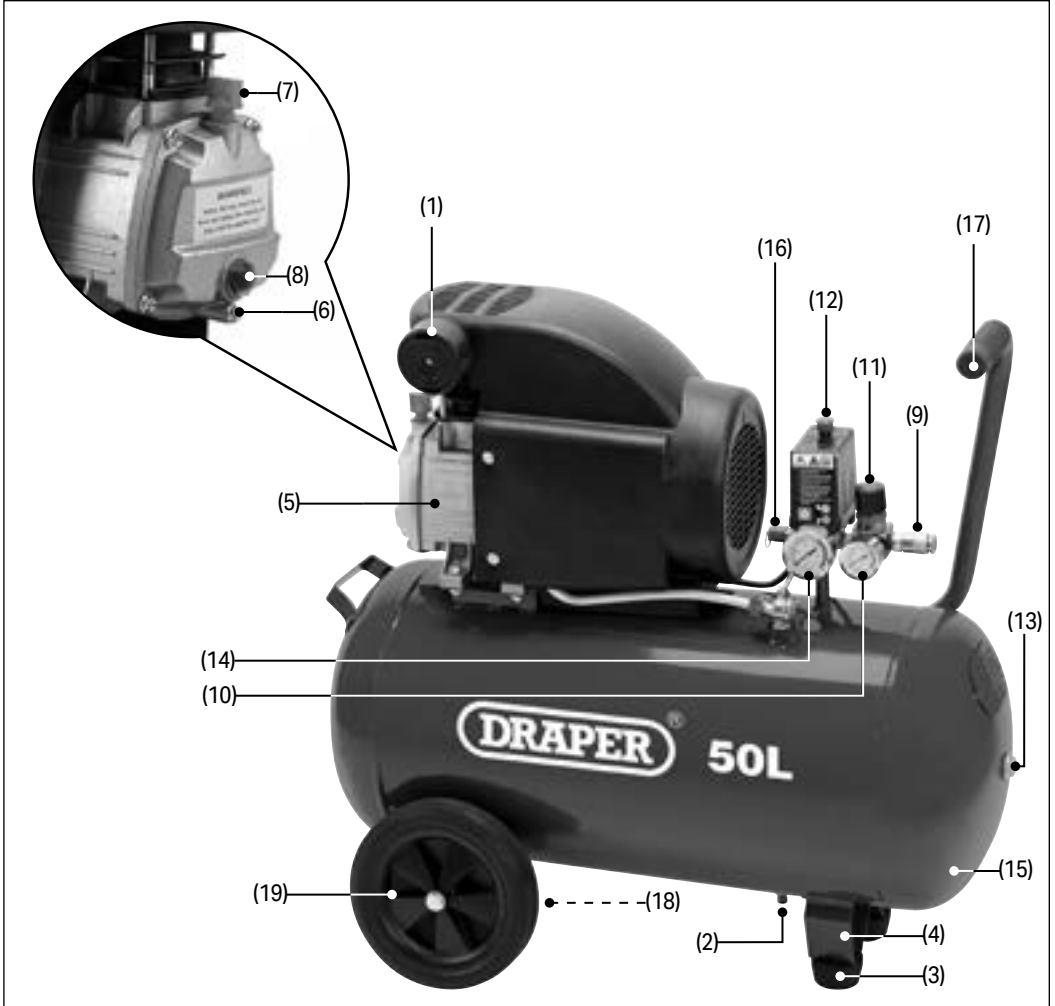

- | | |
|------------------------------|--------------------------------|
| (1) Air filter | (11) Output pressure regulator |
| (2) Drain bung | (12) Pressure switch |
| (3) Feet | (13) Reservoir inspection plug |
| (4) Foot brackets | (14) Reservoir pressure gauge |
| (5) Motor | (15) Reservoir tank |
| (6) Oil drain bolt | (16) Safety valve |
| (7) Oil filler bung | (17) Transport handle |
| (8) Oil level viewing window | (18) Wheel bracket |
| (9) Outlet | (19) Wheels |
| (10) Output pressure gauge | |

5. Identification and Unpacking

5.2 What's in the Box?

Carefully remove the product from the packaging and examine it for any signs of damage that may have occurred during shipment.

Before assembling the product, lay the contents out and check them against the parts shown below. If any part is damaged or missing, do not attempt to use the product. Please contact the Draper Helpline; contact details can be found at the back of this manual.

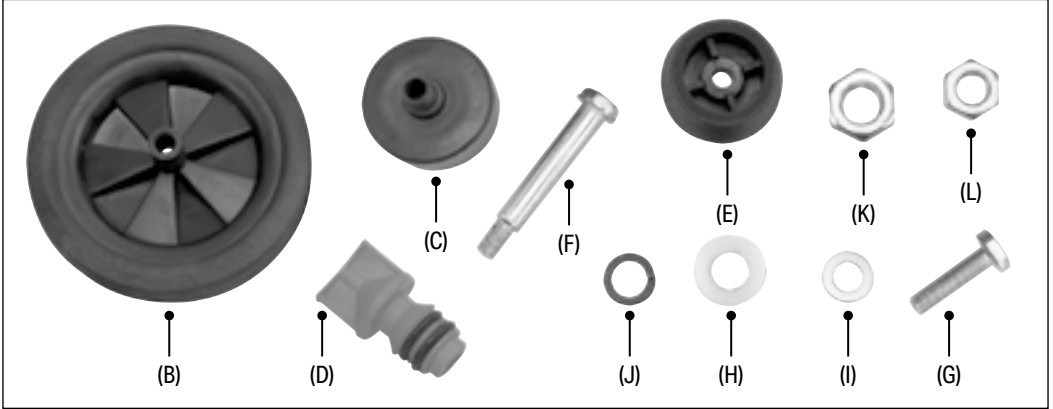

Reference	Description	Quantities	
		24980	24891
(A)	Air compressor unit (not shown)	1	1
(B)	Wheel	2	2
(C)	Air filter	1	1
(D)	Oil filler bung	1	1
(E)	Rubber foot	1	2
(F)	Axle shaft	2	2
(G)	M8 x 30mm hex bolt	—	1
(H)	M10 washer	4	4
(I)	M8 washer	—	4
(J)	M10 spring washer	2	2
(K)	M10 nut	2	2
(L)	M8 nut	—	2

5. Identification and Unpacking

5.3 Packaging

Keep the product packaging for the duration of the warranty period for reference should the product need to be returned for repair.



WARNING! Keep packaging materials out of reach of children. Dispose of packaging correctly and responsibly and in accordance with local regulations.

Please visit [drapertools.com](https://www.drapertools.com) for our full range of accessories and consumables.

6. Preparing the Compressor

Important: Before preparing or adjusting this product, read and understand all the safety instructions listed in this manual. Ensure that the product is disconnected from mains power before making any adjustment.

6.1 Assembly and Installation

Important: Ensure that all parts are installed and firmly secured before use. Some parts may be fitted prior to shipment.

1. Attach the wheels:

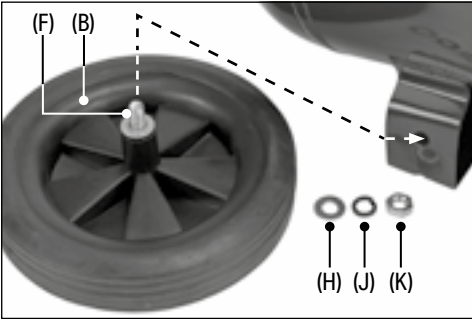

Fig. 1

- Pass an axle shaft (F) through a wheel (B) and place an M10 washer (H) onto the axle.
- Insert the axle through the outer face of a wheel bracket (18).
- Place an M10 washer (H) and an M10 spring washer (J) onto the axle thread and secure it in place with an M10 nut (K).
- Repeat these steps for the other rear wheel.

2. Attach the rubber feet:

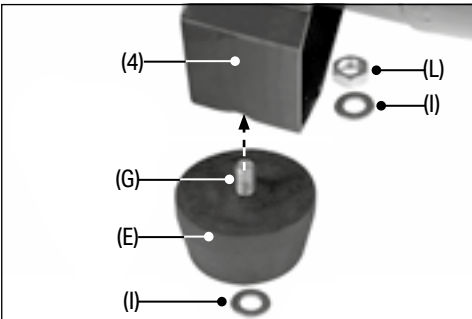

Fig. 2

- Pass an M8 x 30mm bolt (G) through an M8 washer (I) and up through a rubber foot (E).

- Pass the bolt up through the base of a foot bracket (4).
- Place an M8 washer (I) onto the thread and secure it in place with an M8 nut (L).
- Repeat these steps for the other foot.

Important: For 24980, simply insert the rubber foot into the foot socket; no fixings are required.

3. Attach the air filter:



Fig. 3

- Remove the transport bung from the air filter inlet, if applicable.
 - Screw an air filter (C) and into each of the openings.
- Remove the transport bung from the oil fill aperture and insert the oil filler bung (D).

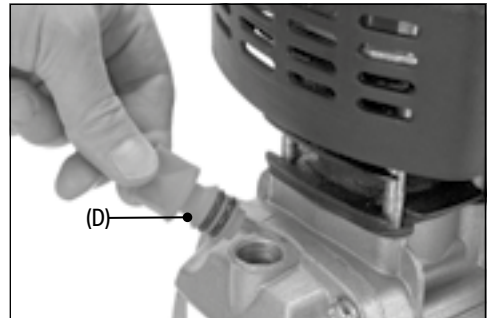

Fig. 4

Position the compressor in a well-ventilated location that offers protection from environmental forces and on a firm and level surface with a gradient of no greater than 10°. Allow at least 1m between the motor (5) and any walls or obstructions to ensure that the flow of air into the machine is not restricted. If the surface is sloped, ensure that the compressor will not move during operation and secure the wheels in place if necessary.

6. Preparing the Compressor

6.2 Topping Up the Oil

CAUTION! This product is **NOT** shipped with oil. Oil **MUST** be added to the product before first use and checked and topped up as appropriate before every use thereafter.

ISO grade 22–32 (SAE grade 5W–15W) monograde oil should be used with this product.

Important: ALWAYS position the compressor on a level surface when checking the oil level.

Important: DO NOT allow the oil level to drop below the minimum level.

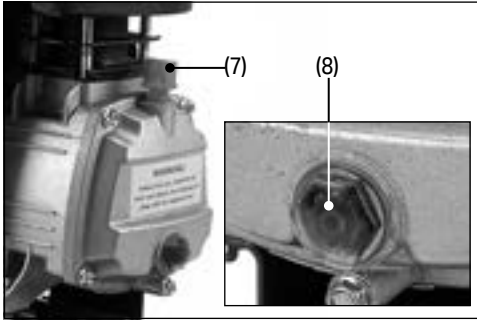

Fig. 5

1. Pull the oil filler bung (7) from the aperture.
2. Using a funnel, pour oil into the reservoir and observe the level through the viewing window (8).
3. When the max level is reached, replace the oil filler bung securely.

Important: The highest and lowest points of the centremost circle in the viewing window indicate the minimum and maximum permissible oil levels.

CAUTION! DO NOT overfill the oil as the excess may flood the airline or damage internal components of the compressor.

6.3 Draining Moisture from the Tank

Over time, compressed air will create moisture within the reservoir. This moisture can mix with the air supply and may cause significant corrosion to connected air tools or to the reservoir tank itself. To prevent this, the reservoir tank should be drained before and after **EVERY** use.

WARNING! Keep hands and other body parts away from the drain bung while draining the moisture from the tank as it may be ejected with considerable force.

To drain the reservoir:

1. Without connecting an air line, start the compressor to generate low internal pressure within the reservoir tank (see 7.2 Switching the Compressor On and Off).
Important: DO NOT apply excess pressure to expel moisture from the tank. The tank pressure should **NOT** exceed 2bar when draining the moisture.
2. Place a container beneath the drain bung (2) on the underside of the tank.
3. Once it has pressurised, carefully loosen the drain bung and allow the air to force any residual moisture from the tank.
4. When no more moisture or air is expelled, clean around the opening and reinstall the drain bung.

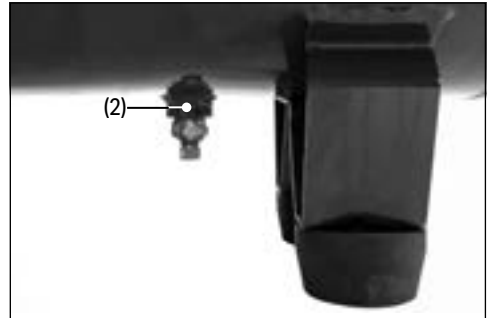



Fig. 6

6.4 Connecting an Air Line or Tool

 **CAUTION!** ALWAYS check the air line requirements for any tools or air lines connected to this device. DO NOT use this compressor with any incompatible air line or tool.

 **WARNING!** ALWAYS ensure that the air line is interrupted and the output pressure is minimal when connecting an air line or tool. DO NOT attempt to connect an air line or tool if air is escaping from the compressor.

Important: ALWAYS ensure that the pressure switch (12) is in the off (depressed) position before attaching or detaching an air line or tool. Draper Tools recommends pressurising the tank first, leaving the output pressure regulator (11) in its lowest position, then connecting the air line and tool.

This device is fitted with a female Euro-style air line adaptor. To connect an air line or tool, insert a male Euro-style air line coupling attached to the item into the outlet (9) and allow the collar to snap back to secure it. Once the air line is connected, the output pressure may be set; see 7.3 Setting the Output Pressure.

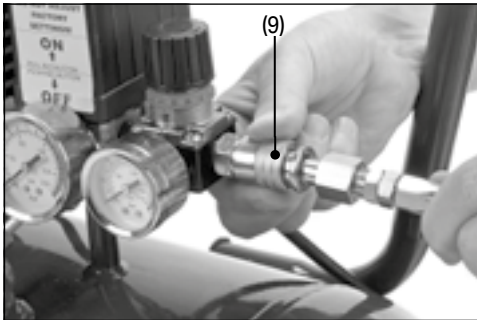

Fig. 7

Important: Draper Tools strongly recommends that this compressor is used with an in-line water separator in the air line to protect your connected tools and any sprayed materials. An in-line lubricator should be used for most air tools, excluding spray guns. An in-line regulator should also be used for greater control over the air line pressure. ALWAYS adhere to the manufacturer instructions of any accessories.

Before connecting a tool to the air line, run the compressor with the air line connected and open to blow any residual moisture from the line.

When using an air tool with a hose over 25ft long, Draper Tools recommends increasing the bore of the hose to the next largest available size (i.e. increase 3/8" to 1/2"). This will ensure adequate pressure and volume of air to power the tool.

Draper Tools recommends that PTFE tape is wrapped around all threaded connections along the air line for a better airtight seal. For best results, wrap the tape in the opposite direction to the thread.

Important: Draper Tools recommends using a suitable whip hose between the connected tool and the air line to reduce vibrations at the tool. Take care as whipping hoses may cause injury.

To detach the connection from the compressor outlet, rotate the output pressure regulator fully anticlockwise and allow the output pressure gauge to drop to zero. Then pull down the collar to eject the connected item.

Important: ALWAYS first allow the outlet pressure to drop to zero and grip the air line when detaching it from the compressor to avoid injury from whipping hoses.

7. Operating Instructions

Important: Before operating this product, read and understand all the safety instructions listed in this manual. The compressor **MUST** be correctly prepared before use.

WARNING! The reservoir tank and motor may become hot during use. **DO NOT** touch heated parts of the product until it has been switched off and allowed to cool thoroughly.

7.1 First-Time Use

When using the compressor for the first time, it must be run until fully pressurised to ensure that the motor stops automatically when the maximum pressure is reached. Ensure that both the drain bung (2) and outlet (9) are closed before pressurising the tank.

If the maximum achievable pressure does not match the rated maximum, depressurise the tank and test again. If the result is consistently incorrect, there may be moisture in the reservoir tank.

Important: Check the maximum pressure periodically to ensure no leakages or moisture build-up are present.

7.2 Switching the Compressor On and Off

Important: This product is **NOT** rated for continuous use. The compressor motor may activate **no more than five times within one hour** of use. **ALWAYS** allow the device to rest and cool before reuse.

Important: If the compressor is being used for the first time after unboxing, perform the first-time use procedure (see **7.1 First-Time Use**) before using the product.

CAUTION! The correct procedure for switching the compressor on and off **MUST** be observed. **Failure to perform the steps in the correct order may cause significant damage to the product.**

The supply of compressed air may still be used when the motor is switched off but the reservoir tank will not repressurise as air is used.

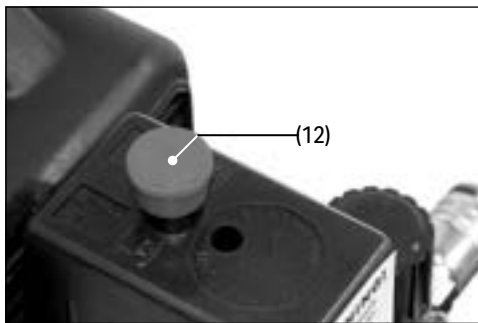

Fig. 8

Switching the Compressor On

1. Ensure that the following have occurred:
 - a. The compressor is correctly assembled and prepared.
 - b. The compressor pressure switch (12) is in the off (depressed) position.
 - c. The output pressure regulator (11) is set to its lowest position.

2. Connect the compressor to mains power.

3. Activate the mains power supply.

Important: A live power supply **MUST** be connected to the compressor **BEFORE** the compressor is switched on at the motor.

4. Grip the pressure switch and pull it upwards to switch on the compressor.
5. The motor will activate and begin to pressurise the reservoir tank.

The motor will stop automatically when the maximum tank pressure is reached. To release air into the air line, rotate the output pressure regulator until the desired pressure is indicated on the output pressure gauge (10).

While the pressure switch remains in the on (raised) position, the motor will automatically restart when the tank pressure drops below the rated cut-in value.

Important: **DO NOT** allow this to occur more than five times within the same 60 minute period.

Switching the Compressor Off

1. If the operation is complete and the compressor will be stored, decompress the reservoir tank (see **7.4 Depressurising the Reservoir Tank**).
2. Push the pressure switch (12) down into the off (depressed) position.

Important: The motor **MUST** be switched off at the compressor **BEFORE** the mains power is disabled.

3. Disable the mains power and disconnect the plug.

 **CAUTION! NEVER unplug the switch or disable the mains power supply to switch off the compressor.**

7.3 Setting the Output Pressure

Important: This compressor delivers a maximum output pressure of 8bar (116psi). **NEVER** exceed the maximum operating pressure of any component of the connected air line.

The output pressure can be set by rotating the output pressure regulator (11) and monitored using the output pressure gauge (10). The current output pressure can only be viewed when the tank is pressurised and air is escaping via the outlet.

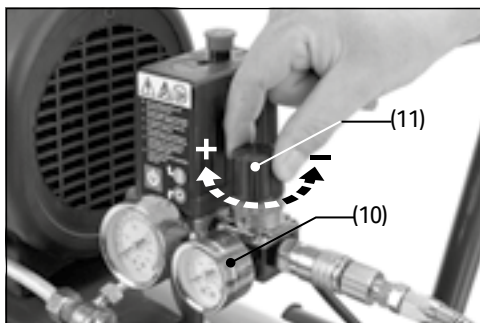

Fig. 9

Important: ALWAYS use the minimum outlet pressure required for the operation. Use of excessive pressure will require the compressor to operate and rest more frequently and may cause the operation to take longer.

- To increase the output pressure, rotate the output pressure regulator clockwise.
- To decrease the output pressure, rotate the output pressure regulator anticlockwise.

Important: When decreasing the pressure, Draper Tools recommends lowering the pressure below the required level and then adjusting upwards for a more accurate result.

Important: If the regulator is rotated to its full extent in either direction, it may require a few turns before the output pressure begins to change.

When the tank pressure reaches the same level as the output pressure, both will decrease at the same rate unless the tank is repressurised.

7.4 Depressurising the Reservoir Tank

Important: ALWAYS ensure that the compressor is switched off and has completely cooled before depressurising the reservoir tank.

The compressor tank must be depressurised when not in use and before the product is moved or stored. To depressurise the tank, use the attached tool to exhaust the pressure.

7.5 Overload Cut-Out

The compressor is equipped with an integral overload cut-out to protect the motor from overuse and overheating. When this occurs, the overload cut-out is activated automatically, shutting off the motor.

The overload cut-out is often activated as a result of the following conditions:

- Low voltage to the compressor
- A clogged air filter
- Insufficient ventilation

If the overload cut-out activates, switch off the machine and disconnect it from the power supply. Allow it to cool for at least 15 minutes before resuming.

If the overload cut-out continues to activate or will not restart after having thoroughly cooled, switch off the compressor and have it serviced by an authorised agent.

7.6 The Safety Valve

Important: The safety valve (16) has been set at the factory to the value rated for this product. **NEVER** adjust the safety valve.

The safety valve automatically relieves pressure within the compressor tank if it exceeds the maximum rated pressure for this device. If the safety valve does not engage when the rated pressure is exceeded, the valve is faulty and **MUST** be replaced.

If the safety valve is activated during use, switch off the compressor and allow the pressure to return to an acceptable level. Check the compressor for blockages or damage before resuming.

If the safety valve is activated frequently, contact Draper Tools for support.

Important: The safety valve **MUST** be replaced every 12 months, regardless of use, by an authorised service agent; contact Draper Tools for support.

8. Maintenance and Troubleshooting

Important: Maintenance and repairs should be carried out **ONLY** by authorised and suitably qualified personnel. **DO NOT** attempt to disassemble the product.

WARNING! ALWAYS ensure that the pressure switch is in the off position, the mains power supply has been disconnected and the tank has been fully depressurised before performing any maintenance on this product.

8.1 General Maintenance

- Drain the compressor tank before and after **EVERY** use; see **6.3 Draining Moisture from the Tank**.
- Regularly clean all finned parts of the compressor to keep the cooling mechanisms in good working order.
- Clean the product using a dry cloth **ONLY**.
 - **NEVER USE** solvents or other aggressive substances to clean this product as they may damage plastic or insulated parts
- Check for signs of corrosion or holes around the compressor tank before and after every use.
 - If there is significant evidence of corrosion, have your product inspected by an authorised service engineer; contact Draper Tools for support.

WARNING! **DO NOT** use the compressor if you suspect that the structural integrity of the tank has been compromised.

- Keep the motor vents and air outlet clear and free from dust and debris.
 - Use a vacuum or compressed gas to clean around the vents and outlet.
- Keep the gauges and safety valve clean and free from debris.

Important: Take care to ensure that the safety valve is not adjusted during cleaning.
- Have the safety valve replaced every **12 months**, regardless of use, by an authorised service agent; contact Draper Tools for support.

8.2 Air Filter Care

Clean the air filter chamber and element at least **once a month** to ensure consistent airflow into the compressor. Increase the frequency of cleaning when working in dusty environments.

WARNING! **NEVER** use petrol or solvents to clean the air filter elements as they may damage the filter or result in a fire when the machine is next used.

CAUTION! **NEVER** run the machine without the air filter elements in place as this may cause the engine to degrade rapidly.



Fig. 10

1. Loosen the air filter (1) housing bolt and remove the housing cover.
2. Remove the filter element and inspect it for holes, tears and obstructions.

Important: If the foam element is damaged, replace it with a new one. **DO NOT** use the machine if the air filter is damaged.
3. Wash the element in warm soapy water and allow it to dry thoroughly.

Important: **DO NOT** use solvents to clean the element.
4. Clean the compartment and covers of any dust, dirt or other obstructions.
5. Reassemble the air filter and fix the housing securely in place.

8.3 Draining and Replacing the Oil

The oil should be replaced after the first **50 hours** of use and then at least once every **six months** thereafter. Check the oil level before **EVERY** use.

Draper Tools recommends draining the oil when the motor is hot to allow the oil to drain more quickly and thoroughly.

1. Unscrew and remove the oil filler bung (7).
2. Loosen the oil drain bolt (6) and allow the old oil to flow into a suitable container.
3. Wipe the affected parts clean and tighten the drain bolt.
4. Pour new oil into the oil filler opening and replace the bung when the max. level of the viewing window (8) has been reached (see **6.2 Topping Up the Oil**).



Fig. 11

CAUTION! NEVER mix used and fresh oil or oils of different types as this may damage internal parts of the product.

Important: Dispose of used oil in accordance with local regulations.

8.4 Valve Care

The non-return valve and intake and delivery valves should be checked every **two years**. Contact Draper Tools for assistance.

8.5 Storing the Compressor

- **ALWAYS**, before storing the product:
 - Disconnect the power supply.
 - Turn the output pressure regulator (11) fully anticlockwise.

- Depressurise and drain the compressor tank; see **6.3 Draining Moisture from the Tank**.

WARNING! DO NOT store the compressor with a pressurised tank.

- Detach the air line or tool and hang the open end vertically downward to drain any residual moisture.
- Open the drain valve.
- Depressurise any other air tools before storing them.
- Store the product in a cool, clean and dry environment, out of direct sunlight and out of the reach of children.
- **DO NOT** store this product in environments exceeding 40°C.
- **ALWAYS** store and transport the product in its upright position.

8. Maintenance and Troubleshooting

8.6 Troubleshooting

Problem	Possible Cause	Remedy
The compressor does not start up.	The mains power supply is not active.	Check the connection to the power supply.
	The compressor is switched off.	Move the pressure switch to the on position.
	The tank is at maximum pressure.	The tank will automatically repressurise when pressure drops to the rated pressure.
	The ambient temperature is too low.	Move the compressor to an environment with an ambient temperature of 0°C or greater.
	The thermal overload safety feature has been activated.	Switch off the compressor and allow it to cool for at least 5 minutes before resetting the safety feature.
The tank or output pressures are abnormally low.	Connections are loose or a seal is damaged.	Inspect all connections for loose fittings or damaged parts. Have any damaged parts replaced immediately*.
	The output pressure regulator is set too low.	Turn the output pressure regulator clockwise to increase the output pressure.
	The safety valve is faulty.	Cease operations immediately and contact Draper Tools for support. DO NOT adjust the safety valve.
Connected air lines and tools are delivering low pressure.	The connected hoses or tools are faulty or are not airtight.	Check connected hoses and tools for signs of cracks, splits or other damage that may cause air leakage.
	Connections are loose or a seal is damaged.	Inspect all connections for loose fittings or damaged parts. Have any damaged parts replaced immediately*.
The tank pressure drops when the compressor is switched off.	The output adaptor or drain valve are loose or clogged.	Check and clean the output adaptor and drain valve as necessary.
	The regulator or gauges are faulty.	Contact Draper Tools for support.
	The safety valve is faulty.	Contact Draper Tools for support.
Air or liquid output from connected tools contains moisture.	Condensation is present in the compressor tank.	Drain the compressor or tank and connected tools and hoses; see 6.4 .
	The environment is too humid.	Move the compressor to a less humid environment.

8.6 Troubleshooting *(continued)*

The compressor starts and stops excessively.	There is excessive moisture inside the tank.	Drain the compressor tank; see 6.4 .
The thermal overload safety feature is triggered repeatedly.	The motor vents are clogged.	Clean the vents using a vacuum or compressed air.
	The environment is poorly ventilated or the ambient temperature is too high.	Move the compressor to an area with increased ventilation and a lower temperature and allow it to cool.
	A valve is malfunctioning.	Contact Draper Tools for support.
The compressor makes an unusual noise or vibrates excessively.	Fixings are loose or the internal mechanism is damaged.	Check that all external bolts are suitably tight. Contact Draper Tools for support.
Oil consumption is excessive.	The oil level is too high.	Drain the oil until the level drops to the maximum permitted volume.
	The breather pipe is blocked.	Check and clean the breather pipe; contact Draper Tools for support.
	The piston ring and cylinder are worn or damaged.	Have the parts replaced; contact Draper Tools for support.

**To identify connections that are not airtight, fully pressurise the reservoir tank and brush all connections with a soapy water solution. Loose or faulty connections will be identified by bubbles emerging from the leak.*

9. Spares, Returns and Disposal

For spare parts, servicing, and repair and replacement options, please contact the Draper Tools Product Helpline for details of your nearest authorised agent.

Draper Tools will endeavour to hold any spare parts, if applicable, for seven years from the date that it sells the final matching stock item.

Any servicing or repairs carried out by unauthorised personnel or installation of spare parts not supplied by Draper Tools will invalidate your warranty.

Important: For safety, **ALWAYS** drain and clean the product of any oil, fuel, chemicals or other substances before returning it to Draper Tools or its authorised agent. Store these materials in suitable containers and dispose of them in accordance with local regulations. Draper Tools and its agents cannot be responsible for the disposal of these substances.

At the end of its working life, dispose of the product responsibly and in line with local regulations. Recycle where possible.

- **DO NOT** dispose of this product with domestic waste; most local authorities provide appropriate recycling facilities.
- **DO NOT** burn or pierce this product.
- Dispose of oil separately and in accordance with local regulations; **DO NOT** abandon it in the environment.



Draper Tools products are carefully tested and inspected before shipment and are guaranteed to be free from defective materials and workmanship.

Should the tool develop a fault, return the complete tool to your nearest distributor or contact Draper Tools directly. Contact information can be found at the back of this manual.

Proof of purchase must be provided.

If, upon inspection, it is found that the fault occurring is due to defective materials or workmanship, repairs will be carried out free of charge. This warranty period covers parts and labour for 12 months from the date of purchase. Where tools have been hired out, the warranty period covers 90 days from the date of purchase.

This warranty does not apply to any consumable parts, batteries or normal wear and tear, nor does it cover any damage caused by misuse, careless or unsafe handling, alterations, accidents, or repairs attempted or made by any personnel other than the authorised Draper Tools repair agent.

In all cases, to make a claim for faulty workmanship or materials within the standard warranty period, please contact or return the product to the place of purchase. Proof of purchase may be required.

If the place of purchase is no longer trading or if you experience any difficulties with your warranty, please contact Customer Services with the product details and your proof of purchase. Contact details can be found at the back of this manual.

If the tool is not covered by the terms of this warranty, repairs and carriage charges will be quoted and charged accordingly.

This warranty supersedes any other guarantees expressed or implied and variations of its terms are not authorised.

Your Draper Tools guarantee is not effective until you can produce, upon request, a dated receipt or invoice to verify your purchase within the guarantee period.

Please note that this warranty is an additional benefit and does not affect your statutory rights.

Draper Tools Limited

11. Explanation of Symbols



Read the instruction manual



Wear face mask and safety glasses



Wear ear defenders



Wear protective gloves



Do not abandon into the environment



Keep out of the reach of children



Warning!



Warning! Pressurised cylinder.



Warning! Heavy object



Do not run machine without oil/lubricant



Do not adjust factory set pressure settings



Mandatory action required



Lift by 2 people



Drain moisture from tank



Remove from packaging



Check oil level



Connect plug to electrical supply



Remove plug from electrical supply



ON/OFF switch



Lift button to switch on



Lift button to switch off



Insert oil plug



Continuous A-Weighted Sound Pressure Level in accordance to and declared according to EN60745



Earthed



This way up



WEEE – Waste Electrical & Electronic Equipment. Do not dispose of Waste Electrical & Electronic Equipment in with domestic rubbish.



Air displacement (cubic feet per minute)



Air displacement (Litres per minute)



Max. pressure (psi)



Max. pressure (bar)



Air tank capacity



Motor capacity (Kilowatts)



Motor capacity (Horse power)



Max. motor speed (Revolutions per minute)

Contact Details

Draper Tools

Draper Tools Limited
Hursley Road
Chandler's Ford
Eastleigh
Hampshire
SO53 1YF
UK

Website: drapertools.com

Email: sales@drapertools.com

Product Helpline: +44 (0) 23 8049 4344

Telephone Sales Desk: +44 (0) 23 8049 4333

General Enquiries: +44 (0) 23 8026 6355

General Fax: +44 (0) 23 8026 0784

Delta International

Delta International BV
Oude Graaf 8
6002 NL
Weert
Netherlands

Please contact the Draper Tools Product Helpline for repair and servicing enquiries.